

# CAREER POINT

## MOCK TEST PAPER for JEE Main (AIEEE)

### Physics, Chemistry & Mathematics

#### Solutions

#### PHYSICS

Ques.	1	2	3	4	5	6	7	8	9	10	11	12	13	14	15
Ans.	4	4	2	3	3	1	4	4	1	3	1	2	1	2	3
Ques.	16	17	18	19	20	21	22	23	24	25	26	27	28	29	30
Ans.	1	3	3	4	4	1	2	4	4	1	1	2	2	2	2

#### CHEMISTRY

Ques.	31	32	33	34	35	36	37	38	39	40	41	42	43	44	45
Ans.	3	1	3	2	2	4	1	2	4	2	3	1	3	2	1
Ques.	46	47	48	49	50	51	52	53	54	55	56	57	58	59	60
Ans.	2	2	1	1	2	2	1	1	4	3	3	4	3	3	3

#### MATHEMATICS

Ques.	61	62	63	64	65	66	67	68	69	70	71	72	73	74	75
Ans.	3	3	2	3	2	3	1	3	2	2	3	4	3	1	3
Ques.	76	77	78	79	80	81	82	83	84	85	86	87	88	89	90
Ans.	3	2	3	1	1	2	1	2	3	2	2	3	2	2	2

#### PHYSICS

1.[4]  $F = \frac{\mu_0}{2\pi} \frac{i_1 i_2}{r}$

$$F' = \frac{\mu_0}{2\pi} \left(\frac{i_1}{3}\right) \left(\frac{i_2}{3}\right) = \frac{F}{27}$$

2.[4] Along the wire  $d\vec{\ell} \times \vec{r} = 0$   
 $\therefore dB = 0$

3.[2] Let  $2a$  be the side of the triangle and  $b$  the length  $AE$ .

$$\frac{AH}{AE} = \frac{GH}{EC}$$

$$\begin{aligned} \therefore GH &= \left(\frac{AH}{AE}\right) EC \\ &= \frac{b-vt}{b} \cdot a = a - \left(\frac{a}{b}\right)vt \end{aligned}$$

$$\therefore FG = 2GH = 2 \left[ a - \frac{a}{b}vt \right]$$

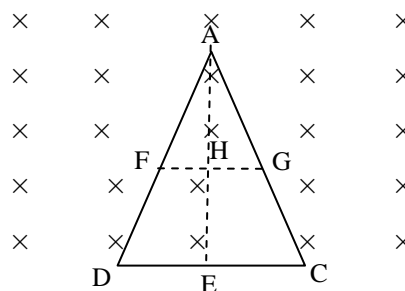

Induced e.m.f.,  $e = Bv(FG) = 2Bv \left( a - \frac{a}{b} vt \right)$

$\therefore$  Induced current,  $I = \frac{e}{R} = \frac{2Bv}{R} \left[ a - \frac{a}{b} vt \right]$

or  $I = k_1 - k_2 t$

Thus,  $I - t$  graph is a straight line with negative slope and positive intercept.

4. [3]  $I = \frac{dq}{dt} = q_0 (\omega \cos \omega t)$

$I = \omega q_0 \cos \omega t$

5. [3]

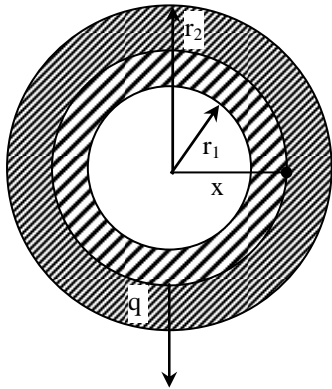

Gaussian surface

$$\oint \vec{E} \cdot d\vec{S} = \frac{q_{in}}{\epsilon_0}$$

$$E \cdot 4\pi x^2 = \frac{q \times \frac{4}{3} \pi (x^3 - r_1^3)}{\frac{4}{3} \pi (r_2^3 - r_1^3) \epsilon_0}$$

$$E = \frac{q}{4\pi \epsilon_0 x^2} \left( \frac{x^3 - r_1^3}{r_2^3 - r_1^3} \right)$$

6. [1]

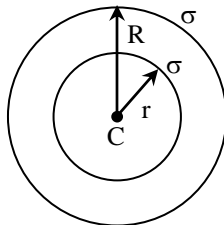

$$V_C = \frac{\sigma r}{\epsilon_0} + \frac{\sigma R}{\epsilon_0}$$

7. [4]

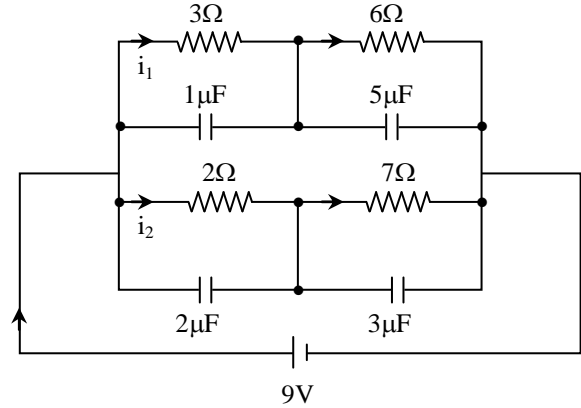

$$i_1 = \frac{9}{3+6} = 1A, i_2 = \frac{9}{2+7} = 1A$$

Pd at  $1\mu F = P.d$  of  $3\Omega$

$$= i_1 \times 3 = 1 \times 3 = 3V$$

$\therefore$  Charge at  $1\mu F = CV = 1\mu F \times 3 = 3\mu C$

P.d. at  $3\mu F = p.d$  at  $7\Omega = i_2 \times 7 = 1 \times 7 = 7V$

Charge at  $3\mu F = CV = 3\mu F \times 7V = 21\mu C$

8. [4] Resistance of an ideal ammeter = 0

$$\therefore V = i \times 0 = 0$$

9. [1]

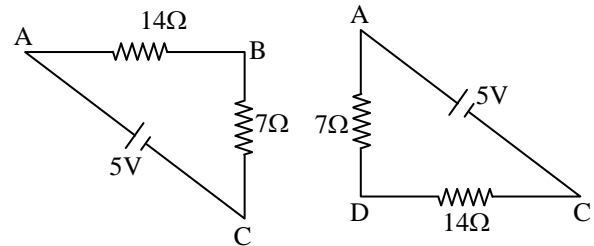

$$V_B - V_C = \frac{7}{14+7} \times 5 = \frac{5}{3} V$$

$$V_D - V_C = \frac{14}{7+14} \times 5 = \frac{10}{3} V$$

$$\therefore V_D - V_B = \frac{10}{3} - \frac{5}{3} = \frac{5}{3} V$$

10. [3] When an object is released from moving frame it will have same velocity as that of frame so packet will have same orbital velocity as that of satellite so it will never reach the earth.

11. [1]

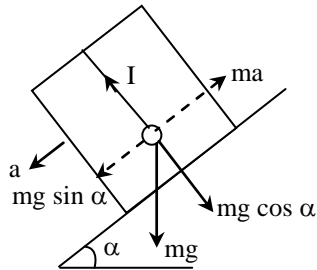

$$g_{\text{eff}} = \frac{T}{m}$$

$$g_{\text{eff}} = \frac{mg \cos \alpha}{m}$$

$$T = 2\pi \sqrt{\frac{L}{g_{\text{eff}}}}$$

$$T = 2\pi \sqrt{\frac{L}{g \cos \alpha}}$$

12. [2]

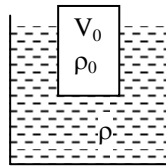

$$V_{\text{in}} \rho g = V_0 \rho_0 g$$

$$\frac{V_{\text{in}}}{V_0} = \frac{\rho_0}{\rho}$$

$$\frac{V_{\text{out}}}{V_0} = 1 - \frac{V_{\text{in}}}{V_0} = 1 - \frac{\rho_0}{\rho}$$

13. [1] By conservation of momentum

$$\vec{P}_i = \vec{P}_f$$

$$m_1 \sqrt{2gd} = (m_1 + m_2)v \quad \dots(1)$$

$$\frac{1}{2}(m_1 + m_2)u^2 = (m_1 + m_2)gh$$

$$h = d \left\{ \frac{m_1}{m_1 + m_2} \right\}^2$$

14. [2]

$$\tau_F > \tau_{Mg}$$

$$F \times 25 > (5g) \times \sqrt{50^2 - 25^2}$$

or  $F > 50\sqrt{3}N$

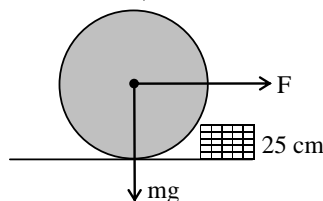

15. [3] Line =  $n - 1 = 3$

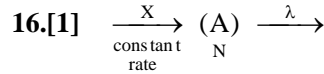

No. of nuclei of A will be maximum when the radioactive equilibrium is established.  
Rate of formation of A = Rate of decay of A

$$X = \lambda N \left( \lambda = \frac{\ln 2}{T_H} = \frac{\ln 2}{Y} \right)$$

$$X = \frac{\ln 2}{Y} N$$

$$N = \frac{XY}{\ln 2}$$

17. [3]  $E = \frac{hc}{\lambda} - \phi_0 \quad \dots(1)$

$2E = \frac{hc}{\lambda'} - \phi_0 \quad \dots(2)$

on solving  $\lambda' = \frac{hc\lambda}{E\lambda + hc}$

18. [3] Transverse elastic waves can propagate in solid and on the water surface.

19. [4]  $y = 4 \sin 2\pi \left( \frac{t}{0.02} - \frac{x}{100} \right)$

compare it with the standard eq<sup>n</sup>

$$y = A \sin 2\pi \left( \frac{t}{T} - \frac{x}{\lambda} \right)$$

So  $T = 0.02 \text{ sec}$

$$n = \frac{1}{T} = \frac{1}{0.02} = 50 \text{ Hz} \quad \dots(i)$$

$$\lambda = 100 \text{ cm} = 1 \text{ m}$$

$$\text{Wave velocity } v = n\lambda = 50 \text{ m/sec}$$

$$\text{Maximum particle velocity } V_{\text{max}} = A\omega$$

$$= 4 (2\pi \times 50) = 400\pi \text{ cm/sec}$$

$$= 4\pi \text{ m/sec}$$

21. [1]  $d = \sqrt{2Rh}$

$$N = \pi d^2 \sigma = 2\pi Rh \sigma$$

$$= 2 \times 3.14 \times 6400 \times 0.1 \times 1000$$

$$= 2 \times 3.14 \times 6.4 \times 10^5$$

$$= 39.5 \times 10^5$$

22. [2]  $\frac{\Delta X}{X} \times 100 = \left[ 3 \frac{\Delta a}{a} + 2 \frac{\Delta b}{b} + \frac{\Delta d}{d} + \frac{1}{2} \frac{\Delta c}{c} \right] \times 100$

$$= 3 \times 1 + 2 \times 3 + 4 + \frac{1}{2} \times 2$$

$$= 3 + 6 + 4 + 1 = 14 \%$$

23. [4] If  $t$  is the time of flight, then

$$0 = vt - \frac{1}{2} g \cos \theta t^2$$

$$t = \frac{2v}{g \cos \theta}$$

$$\Rightarrow R = 0 + \frac{1}{2} g \sin \theta t^2$$

$$R = \frac{1}{2} g \sin \theta \times \left( \frac{2v}{g \cos \theta} \right)^2$$

$$R = \frac{2v^2}{g} \tan \theta \sec \theta$$

24. [4] Angular magnification =  $-\frac{f_o}{f_e} = \frac{16m}{2cm} = -800$

Length of tube  $L = f_o + f_e = 16.02$  m  
-ve sign represents inverted image.

25. [1] Angular separation of two adjacent maxima is

$$\Delta \theta = \frac{\lambda}{d}$$

Let angular separation be 10 % greater for wavelength  $\lambda'$

$$\text{their } \frac{1.1\lambda}{d} = \frac{\lambda'}{d}$$

$$\lambda' = 1.10 \lambda = 648 \text{ nm}$$

26. [1] Least count of V.C. =  $\frac{1}{10} = 0.1$  mm

Side of cube =  $10\text{mm} + 1 \times 0.1\text{mm} = 1.01$  cm

$$\text{density} = \frac{\text{mass}}{\text{volume}} = \frac{2.736\text{g}}{(1.01)^3 \text{cm}^3} = 2.66 \text{ g/cm}^3$$

27. [2]  $P = P_0 - aV^2$

From ideal gas equation

$$PV = nRT$$

$$(P_0 - aV^2) V = nRT$$

$$T = \frac{P_0 V}{nR} - \frac{aV^3}{nR}$$

$$\frac{dT}{dV} = \frac{P_0}{nR} - \frac{3aV^2}{nR} = 0$$

$$P_0 = 3aV^2 \Rightarrow V = \sqrt{\frac{P_0}{3a}}$$

$$P = P_0 - a \left( \frac{P_0}{3a} \right)$$

$$P = \frac{2P_0}{3}$$

$$\left( \frac{2P_0}{3} \right) \sqrt{\frac{P_0}{3a}} = nRT_{\max}$$

$$T_{\max} = \left( \frac{2P_0}{3nR} \right) \left( \frac{P_0}{3a} \right)^{1/2}$$

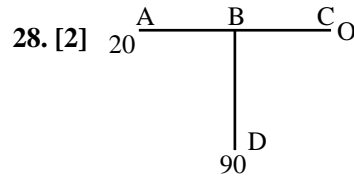

$$H_{AB} = 0$$

$$H_{DB} = H_{BC}$$

[means  $T_A = T_B = 20$ ]

$$\frac{KA(90-20)}{\ell_{BD}} = \frac{KA(20-0)}{\ell_{BC}}$$

$$= \frac{\ell_{BD}}{\ell_{BC}} = \frac{7}{2}$$

29. [2] Reading =  $2T$

$$= \frac{4m_1 m_2 (g+a)}{m_1 + m_2}$$

$$= 8 \text{ g}$$

30. [2]

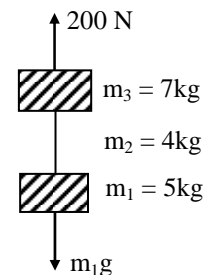

$$200 - 160 = 16a$$

$$40 = 16a$$

$$a = \frac{10}{4} = \frac{5}{2}$$

$$a = 2.5 \text{ m/s}^2$$

$$200 - 70 - T = 7 \times a$$

$$130 - T = 7 \times 2.5$$

$$130 - T = 17.5$$

$$T = 130 - 17.5$$

$$T = 112.5 \text{ N}$$

# CHEMISTRY

31.[3]

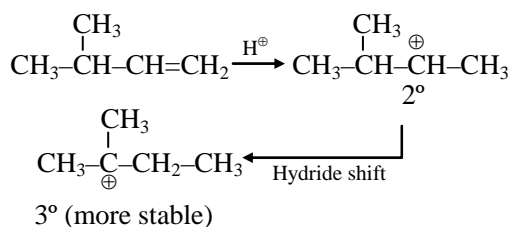

32.[1]

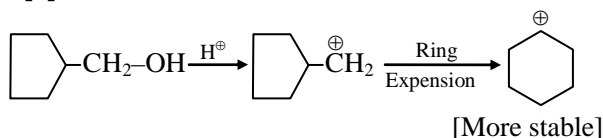

33.[3] De carboxylation due to steric hindrance

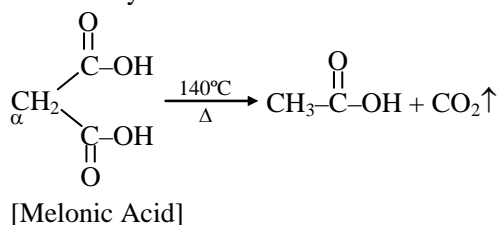

34.[2]

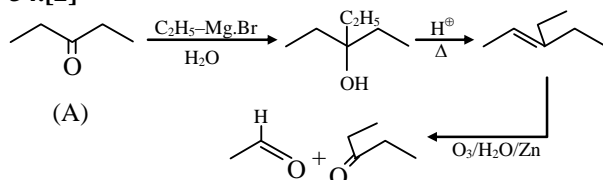

35.[2] Zn → ZnS  
Cu → CuFeS<sub>2</sub>  
Pb → PbS

Compound	No. of unpaired e <sup>-</sup>
[MnCl <sub>4</sub> ] <sup>-2</sup>	5
[CoCl <sub>4</sub> ] <sup>-2</sup>	3
[Fe(CN) <sub>6</sub> ] <sup>-4</sup>	0

Compound	No. of ions per molecule
[Pt(NH <sub>3</sub> ) <sub>5</sub> Cl]Cl <sub>3</sub>	4
[Pt(NH <sub>3</sub> ) <sub>6</sub> ]Cl <sub>4</sub>	5
[Pt(NH <sub>3</sub> ) <sub>2</sub> Cl <sub>4</sub> ]	0
[Pt(NH <sub>3</sub> ) <sub>4</sub> Cl <sub>2</sub> ]Cl <sub>2</sub>	3

38.[2] (NH<sub>4</sub>)<sub>2</sub>Cr<sub>2</sub>O<sub>7</sub>  $\xrightarrow{\Delta}$  N<sub>2</sub> + Cr<sub>2</sub>O<sub>3</sub> + H<sub>2</sub>O

39.[4] 'I' can not form 4 bonds

40.[2] Zn(NO<sub>3</sub>)<sub>2</sub>  $\xrightarrow{\Delta}$  ZnO + NO<sub>2</sub> + O<sub>2</sub>

41.[3] Ionic compounds are solid due to presence of strong electrostatics force of attraction.

42.[1] Down the group solubility of alkali metal hydroxide is increases.

So correct order

LiOH < NaOH < KOH < RbOH < CsOH

43.[3] ΔG = ΔH - TΔS

$$\Delta H - T\Delta S < 0$$

$$-38.3 \times 10^3 - T(-113) < 0$$

$$T < 338.93 \text{ K (i.e. } 66^\circ\text{C)}$$

44.[2] According to third law of thermodynamics.

45.[1] NH<sub>4</sub>COO NH<sub>2</sub>(s)  $\rightleftharpoons$  2NH<sub>3</sub>(g) + CO<sub>2</sub>(g)

2P	P
= 2	= 1
3P = 3	
P = 1	

$$K_P = P_{\text{NH}_3}^2 \cdot P_{\text{CO}_2}$$

$$= 2^2 \times 1 = 4.$$

46.[2] For -ve deviation ΔH<sub>mixing</sub> = -ve  
and ΔV<sub>mixing</sub> = -ve

47.[2] a = 2 (r<sup>+</sup> + r<sup>-</sup>)  
400 = 2 (80 + r<sub>a</sub>)  
∴ r<sub>a</sub> = 120

48.[1] E° =  $\frac{0.0591}{2} \log K_{\text{eq}}$

$$\log K_{\text{eq}} = \frac{2 \times 0.22}{0.0591} = 7.44$$

$$K_{\text{eq}} = 2.8 \times 10^7$$

49.[1] According to arrhenius equation,  
K = A.e<sup>-Ea/RT</sup>

$$50.[2] K = \frac{2.303}{t} \log \left[ \frac{C_{A_0}}{C_A} \right]$$

$$2.303 \times 1 = 2.303 \log \left[ \frac{C_{A_0}}{C_A} \right]$$

$$\frac{C_{A_0}}{C_A} = 10$$

$$\therefore C_A = \frac{1}{10} = 0.1$$

$$\therefore \text{rate after 1 min, } r_1 = KC_A \\ = 2.303 \times 0.1 = 0.2303 \text{ M.min}^{-1}$$

51.[2] Phenelzine is use as a antidepressant.

52.[1] Both the structure of starch (Amylose and amylopectine) are formed by  $\alpha$ -D glucose.

53.[1]

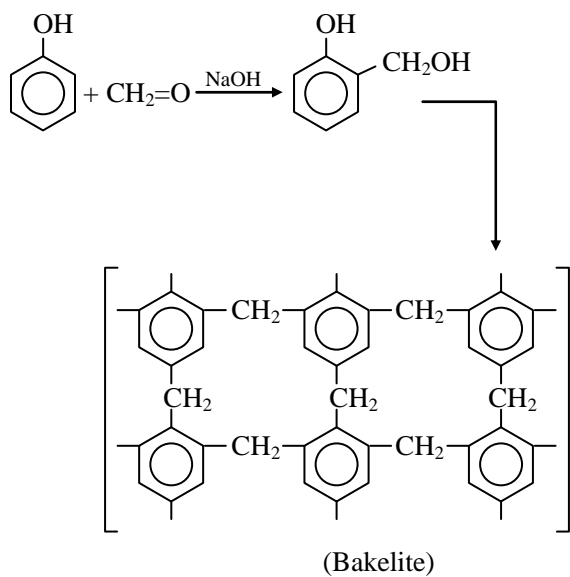

54.[4]

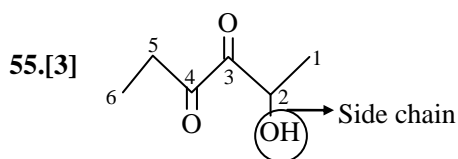
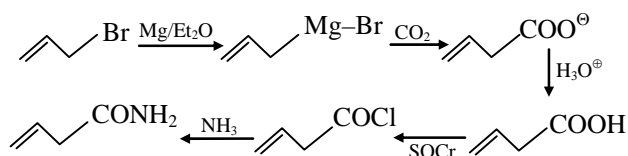

56.[3]

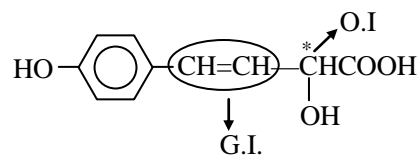

Both O.I. & G.I. possible.

57.[4]

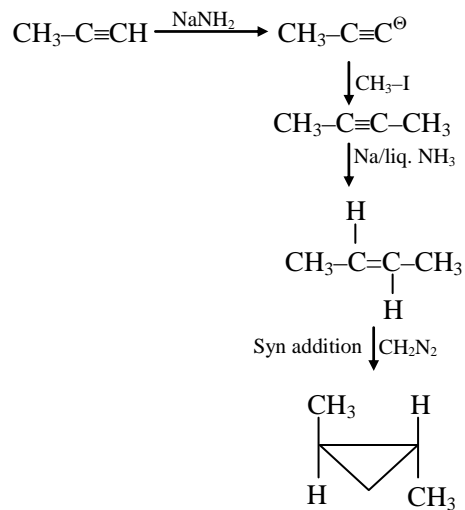

( $\pm$ ) Trans-1,2-dimethylcyclopropane.

58.[3]  $\lambda = \frac{h}{mv}$  and  $v \propto \sqrt{T}$

$$\frac{\lambda_1}{\lambda_2} = \sqrt{\frac{T_2}{T_1}}$$

$$= \frac{\lambda_1}{\lambda_2} = \sqrt{\frac{1200}{300}}$$

$$\lambda_2 = \frac{\lambda}{2}$$

60.[3] Let the mass of mixture = 100 gm

Mass of  $\text{CO}_2$  = 66 gm

Mass of  $\text{H}_2$  = 34 gm

$$\text{no. of moles of } \text{CO}_2 = \frac{66}{44} = 1.5$$

$$\text{no. of moles of } \text{H}_2 = \frac{34}{2} = 17$$

$$\text{total no. of moles} = \frac{\text{mass of mixture}}{M_{av}}$$

$$M_{av} = \frac{100}{18.5} = 5.4$$

$$V.D. = \frac{M}{2} = \frac{5.4}{2}$$

$$= 2.7$$

## MATHEMATICS

**61.[3]** The tangent of slope  $m$  must be of the form

$$y = m(x + 2) + \frac{a}{m}$$

$$\text{So, } 2m + \frac{2}{m} = c \Rightarrow c = 2\left(m + \frac{1}{m}\right) \geq 2 \times 2. \text{ So}$$

$$c_{\min} = 4$$

**62.[3]**  $\vec{a} + \vec{b} = \vec{p}$

$$\Rightarrow |\vec{a} + \vec{b}|^2 = |\vec{p}|^2$$

$$\Rightarrow (\vec{a} + \vec{b}) \cdot (\vec{a} + \vec{b}) = |\vec{p}|^2$$

$$= |\vec{a}|^2 + |\vec{b}|^2 + 2\vec{a} \cdot \vec{b} = |\vec{p}|^2$$

$$\text{Also, } \vec{a} - \vec{b} = \vec{q}$$

$$\Rightarrow |\vec{a} - \vec{b}|^2 = |\vec{q}|^2$$

$$\Rightarrow (\vec{a} - \vec{b}) \cdot (\vec{a} - \vec{b}) = |\vec{q}|^2$$

$$= |\vec{a}|^2 + |\vec{b}|^2 - 2\vec{a} \cdot \vec{b} = |\vec{q}|^2$$

$$\text{Thus } 2(|\vec{a}|^2 + |\vec{b}|^2) = |\vec{p}|^2 + |\vec{q}|^2$$

**63.[2]** Equation of the required plane is

$$(x + y + z - 6) + \lambda(2x + 3y + z + 5) = 0$$

$$\text{i.e. } (1 + 2\lambda)x + (1 + 3\lambda)y + (1 + \lambda)z + (-6 + 5\lambda) = 0$$

This plane is perpendicular to  $xy$  plane whose equation is  $z = 0$

$$\text{i.e. } 0 \cdot x + 0 \cdot y + z = 0$$

$\therefore$  By condition of perpendicularity

$$0 \cdot (1 + 2\lambda) + 0 \cdot (1 + 3\lambda) + (1 + \lambda) \cdot 1 = 0$$

$$\text{i.e. } \lambda = -1$$

$\therefore$  Equation of required plane is

$$(1 - 2)x + (1 - 3)y + (1 - 1)z + (-6 - 5) = 0$$

$$\text{or } x + 2y + 11 = 0.$$

**64.[3]** We have

$$f(x) = \sin(\log(-x + \sqrt{1+x^2}))$$

$$f(-x) = \sin(\log(x + \sqrt{1+x^2}))$$

$$= \sin \log \left( \left( x + \sqrt{1+x^2} \right) \left( \frac{-x + \sqrt{1+x^2}}{-x + \sqrt{1+x^2}} \right) \right)$$

$$= \sin \log \left( \frac{1}{-x + \sqrt{1+x^2}} \right)$$

$$= -\sin \log \left( -x + \sqrt{1+x^2} \right)$$

$= -f(x)$  odd function, hence zero (S-I) is true.

$$\int_{-a}^a f(x) dx = 0 \text{ only when, } f(x) \text{ is odd function}$$

Hence S-II is wrong.

**65.[2]**

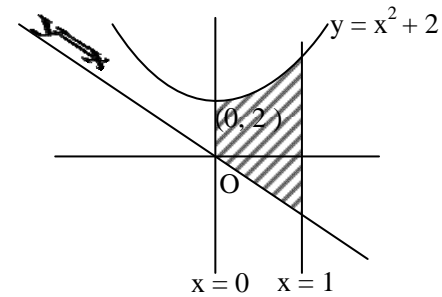

Required shaded area

$$= \int_0^1 ((x^2 + 2) - (-x)) dx$$

$$= \int_0^1 (x^2 + x + 2) dx = \left( \frac{x^3}{3} + \frac{x^2}{2} + 2x \right)_0^1$$

$$= \frac{1}{3} + \frac{1}{2} + 2 = \frac{17}{6}$$

**66.[3]** We have

$$y - x \frac{dy}{dx} = y^2 + \frac{dy}{dx}$$

$$(x + 1) \frac{dy}{dx} = y - y^2$$

$$\frac{dy}{y(1-y)} = \frac{dx}{x+1}$$

$$\left( \frac{1}{y} + \frac{1}{1-y} \right) dy = \frac{dx}{x+1}$$

On integrating both side, we get

$$\log y - \log(1-y) = \log(x+1) + \log c$$

$$\log \left( \frac{y}{y-1} \right) = \log(x+1)c$$

$$\frac{y}{y-1} = (x+1)c$$

$$c'y = (x+1)(y-1)$$

67.[1]

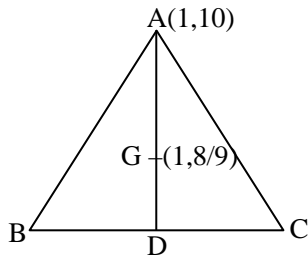

Circumcentre  $O \equiv (-1/3, 2/3)$  and orthocenter  $H \equiv (11/3, 4/3)$ .

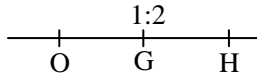

Therefore, the coordinates of G are  $(1, 8/9)$ . Now, the point A is  $(1, 10)$  as G is  $(1, 8/9)$ . Hence,  $AD : DG = 3 : 1$

$$\therefore D_x = \frac{3-1}{2} = 1, D_y = \frac{8-10}{2} = -\frac{11}{3}$$

Hence, the coordinates of the mid-point of BC are  $(1, -11/3)$ .

68.[3]

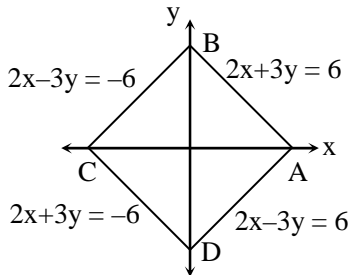

The given inequality represents a rhombus with sides  $2x \pm 3y = 6$  and  $2x \pm 3y = -6$

$$\text{Area} = \frac{2c^2}{db} = \frac{2(6)^2}{(2)(3)} = 12$$

69.[2]  $c_1 = (1, 2), r_1 = \sqrt{1+4+95} = 10$

$c_2 = (3, 4); r_2 = \sqrt{9+16-16} = 3$

$c_1 c_2 = \sqrt{(3-1)^2 + (4-2)^2} = \sqrt{8} = 2\sqrt{2}$

$\therefore c_1 c_2 < |r_1 - r_2|$  (one circle lies inside the other)

$\therefore$  The statement-I is true and statement-II is also true and correct explanation of statement-I.

70.[2]  $\int \frac{dx}{x^2 \cdot x^{n-1} [1+x^{-n}]^{\frac{n-1}{n}}}$

$\int \frac{dx}{x^{n+1} (1+x^{-n})^{\frac{n-1}{n}}}$

Put  $1+x^{-n} = t^n$

$$\frac{dx}{x^{n+1}} = t^{n-1} dt$$

71.[3] for point of intersection at exactly one point

$$\lambda x + 3 = (\lambda + 1)x^2 + 2$$

$$(\lambda + 1)x^2 - \lambda x - 1 = 0$$

$$\Delta = 0$$

$$\lambda^2 + 4(\lambda + 1) = 0$$

$$\lambda^2 + 4\lambda + 4 = 0$$

$$(\lambda + 2)^2 = 0$$

$$\lambda = -2$$

72.[4]

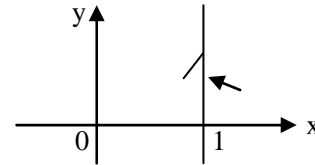

$$V \geq R$$

$$5 \geq -2(1+h) + \log_2(b^2-2)$$

solve for b then  $b^2 - 2 > 0$

73.[3]

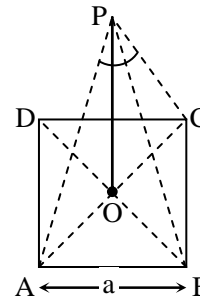

Let side of square = a

then  $OA = a/\sqrt{2}$

As  $\angle OPA = 45^\circ$

$OA = OP = a/\sqrt{2}$

Clearly,  $AP = a = BP$

As  $AB = a$

So,  $\triangle ABP$  be equilateral  $\Delta$

Hence  $\angle APB = 60^\circ$

74.[1] Put  $\frac{1}{2} \cos^{-1} \frac{\sqrt{5}}{3} = \theta$

$$\Rightarrow \cos 2\theta = \frac{\sqrt{5}}{3} \text{ and } 0 \leq 2\theta \leq \pi$$

$$\Rightarrow \frac{1 - \tan^2 \theta}{1 + \tan^2 \theta} = \frac{\sqrt{5}}{3}$$

$$\Rightarrow \frac{1 + \tan^2 \theta}{1 - \tan^2 \theta} = \frac{3}{\sqrt{5}}$$

$$\Rightarrow \tan^2 \theta = \frac{3 - \sqrt{5}}{3 + \sqrt{5}} = \frac{(3 - \sqrt{5})^2}{4}$$



$$\Rightarrow \tan\theta = \pm \frac{3-\sqrt{5}}{2}$$

$$\Rightarrow \tan\theta = \frac{3-\sqrt{5}}{2} \text{ As } 0 \leq \theta \leq \pi/2$$

75.[3] Since  $A \subseteq B$ ,  $\therefore A \cup B = B$   
So,  $n(A \cup B) = n(B) = 6$

76.[3]  $(\log_3 512 \log_4 9 - \log_3 8 \log_4 3)$   
 $\times (\log_2 3 \log_3 4 - \log_3 4 \log_2 3)$

$$= \left( \frac{\log 512}{\log 3} \frac{\log 9}{\log 4} - \frac{\log 8}{\log 3} \frac{\log 3}{\log 4} \right) \times$$

$$\left( \frac{\log 3}{\log 2} \frac{\log 4}{\log 3} - \frac{\log 4}{\log 3} \frac{\log 3}{\log 2} \right)$$

$$= \left( \frac{9 \log 2}{\log 3} \frac{2 \log 3}{2 \log 2} - \frac{3 \log 2}{\log 3} \frac{\log 3}{2 \log 2} \right) \times$$

$$\left( \frac{\log 3}{\log 2} \frac{2 \log 2}{\log 3} - \frac{2 \log 2}{\log 3} \frac{\log 3}{3 \log 2} \right)$$

$$= \left( 9 - \frac{3}{2} \right) \left( 2 - \frac{2}{3} \right) = 10$$

77.[2]  $\frac{\alpha}{10} = (A^{-1})_{23} = \frac{C_{32}}{|A|} = \frac{-\begin{vmatrix} 1 & 1 \\ 2 & -3 \end{vmatrix}}{10} = \frac{5}{10} \Rightarrow \alpha = 5$

78.[3] mean  $(\mu) = \frac{\sum f_i y_i}{\sum f_i}$

$$\sum f_i (y_i - \mu) = \sum f_i y_i - \mu \sum f_i = 0$$

Statement-I is true.

Again the mean of the square of the first n

$$\text{natural numbers} = \frac{\sum n^2}{n}$$

$$= \frac{n(n+1)(2n+1)}{6n} = \frac{(n+1)(2n+1)}{6}$$

Statement-II is false .

79.[1] Clearly (a) is wrong as it is ' $\vee$ ' operator

80.[1]

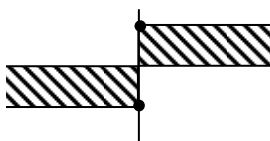

odd function

$$(\text{sgn}(x)^{\text{sgn} x})^n = \begin{cases} ((1)^1)^n & ; x > 0 \\ ((-1)^{-1})^n & ; x < 0 \end{cases}$$

$$= \begin{cases} 1; & x > 0 \\ -1; & x < 0 \end{cases}$$

81.[2] Do your self

82.[1] Given  $f \circ g = I$

$$\Rightarrow f \circ g(x) = x \text{ for all } x$$

$$\Rightarrow f'(g(x)) g'(x) = 1 \text{ for all } x$$

$$\Rightarrow f'(g(a)) = \frac{1}{g'(a)} = \frac{1}{2}$$

$$\Rightarrow f'(b) = \frac{1}{2}$$

83.[2] After solving the determinant

$$a^3 + b^3 + c^3 - 3abc = 0$$

$$(a + b + c) \cdot (a^2 + b^2 + c^2 - ab - bc - ca) = 0$$

$$\frac{1}{2} (a + b + c) [(a - b)^2 + (b - c)^2 + (c - a)^2] = 0$$

$$\therefore (a - b)^2 + (b - c)^2 + (c - a)^2 = 0$$

$$\therefore a = b = c \quad [\because a + b + c \neq 0 \therefore z_1 \neq 0]$$

because  $|z_1| = a \neq 0$  etc]

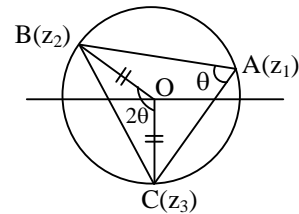

Hence  $OA = OB = OC$

where O is the origin and A, B, C are the points representing  $z_1, z_2, z_3$  respectively.

Therefore, O is circumcentre of  $\Delta ABC$ .

$$\arg\left(\frac{z_3}{z_2}\right) = \angle BOC = 2\angle BAC$$

$$= 2\arg\left(\frac{z_3 - z_1}{z_2 - z_1}\right) = \arg\left(\frac{z_3 - z_1}{z_2 - z_1}\right)^2$$

84.[3] let  $a_1 = 1$

$$a_2 = 2$$

$$a_3 = 4$$

$$a_4 = 8$$

So,  $b_1 = 1$

$$b_2 = 1 + 2 = 3$$

$$b_3 = 3 + 4 = 7$$

$$b_4 = 7 + 8 = 15$$

The numbers  $b_1, b_2, b_3, b_4$  are not in G.P. and A.P.

Statement-I is correct but Statement-II wrong.

85.[2] If  $(x + 2)^2 = (\omega - \omega^2)^2$

$$x^2 + 4 + 4x = \omega^2 + \omega^4 - 2\omega^3$$

$$x^2 + 4 + 4x = \omega^2 + \omega - 2$$

$$(x^2 + 4x + 7) = 0 \quad \dots(i)$$

$$x^4 + 3x^3 + 2x^2 - 11x - 6$$

$$= x^2(x^2 + 4x + 7) - x(x^2 + 4x + 7) - (x^2 + 4x + 7) + 1$$

$$= x^2(0) - x(0) - 0 + 1 \quad \text{By (i)}$$

$$= 1$$

86.[2]  $T_{r+1} = {}^{1024}C_r (5^{1/2})^{1024-r} (7^{1/8})^r$

Now this term is an integer if  $1024 - r$  is an even integer, for which

$r = 0, 2, 4, 6, \dots, 1022, 1024$  of which  $r = 0, 8, 16,$

$24, \dots, 1024$  are divisible by 8 which makes  $r/8$  an integer.

For A.P.,  $r = 0, 8, 16, 24, \dots, 1024$

$$1024 = 0 + (n - 1)8 \Rightarrow n = 129$$

87.[3] Sum of coefficients in  $(1 - x \sin\theta + x^2)^n$  is  $(1 - \sin\theta + 1)^n$  (putting  $x = 1$ )

This sum is greatest when  $\sin\theta = -1$ , then maximum sum is  $3^n$ .

88.[2] Suppose there 'n' players in the beginning. The total number of games to be played was equal to  ${}^nC_2$  and each player would have played  $n - 1$  games.

Let us assume that A and B fell ill. Now the total number of games of A and B is  $(n - 1) + (n - 1) - 1 = 2n - 3$ . But they have played 3 games each. Then their remaining number of games is  $2n - 3 - 6 = 2n - 9$ . Given,

$${}^nC_2 - (2n - 9) = 84$$

$$\Rightarrow n^2 - 5n - 150 = 0$$

$$\Rightarrow n = 15$$

**Alternative solutions :**

The number of games excluding A and B is  ${}^{n-2}C_2$ . But before leaving A and B played 3 games each. Then,  ${}^{n-2}C_2 + 6 = 84$

Solving this equation, we get  $n = 15$ .

89.[2]  $P = \frac{|n-2| \times 2}{|n-1|} = \frac{2}{n-1} = \frac{2}{2+n-3}$

odds against =  $n - 3 : 2$

90.[2]  $P(A) = \frac{1}{1+2} = \frac{1}{3}$

$$P(A \cup B) = \frac{3}{3+1} = \frac{3}{4}$$

$$P(A \cup B) = P(A) + P(B) - P(A \cap B)$$

$$\Rightarrow P(B) = \frac{3}{4} - \frac{1}{3} + P(A \cap B)$$

$$P(B) = \frac{5}{12} + P(A \cap B) \quad \Rightarrow \frac{5}{12} \leq P(B) \leq 3/4$$